

 XIAMEN DEXIAN ELECTRONICS TECHNOLOGY CO., LTD	PRODUCT SPECIFICATION	ISSUED DATE:	2019/08/20
		REV. NO.:	A00
	SERIES: 6TS	DOC. NO.:	DX-PSI-002
		PAGE	PAGE 1 OF 8

制定 PREPARED BY		审核 CHECKED BY		批准 APPROVED BY	
-------------------	---	------------------	---	-------------------	---

1 适用范围/ SCOPE

本规格书适用于公司生产并获得 UR、cUR、TUV 安全标准认证的 6TS RoHS 系列 DXFUSE® 商标的小型保险丝管。

This specification defines the technical requirements of miniature fuse type 6TS RoHS series with DXFUSE® brand, which are approved by UR, cUR and TUV.

产品部件号为: 型号 额定电流 额定电压
Construction of part no.: type rated current rated voltage
例如/ Example: 6TS 080 H

* 额定电压/ Rated Voltage: L-125V /H - 250V/ H₁ - 300V

产品部件号/ PART NUMBER

PART NUMBER	额定电流 RATED CURRENT	额定电压 RATED VOLTAGE	PART NUMBER	额定电流 RATED CURRENT	额定电压 RATED VOLTAGE
6TS-010L/H/H ₁	1A	125V/250V/300V	6TS-063L/H/H ₁	6.3A	125V/250V/300V
6TS-013L/H/H ₁	1.25A		6TS-070L/H/H ₁	7A	
6TS-015L/H/H ₁	1.5A		6TS-080L/H/H ₁	8A	
6TS-016L/H/H ₁	1.6A		6TS-090L/H/H ₁	9A	
6TS-020L/H/H ₁	2A		6TS-100L/H/H ₁	10A	
6TS-025L/H/H ₁	2.5A		6TS-120L/H/H ₁	12A	
6TS-030L/H/H ₁	3A		6TS-130L/H/H ₁	12.5A	
6TS-032L/H/H ₁	3.15A		6TS-150L/H/H ₁	15A	
6TS-035L/H/H ₁	3.5A		6TS-160L/H/H ₁	16A	
6TS-040L/H/H ₁	4A		6TS-200L/H/H ₁	20A	
6TS-050L/H/H ₁	5A		6TS-250L/H/H ₁	25A	
6TS-060L/H/H ₁	6A		6TS-300L/H/H ₁	30A	

2 相关标准/ APPLICABLE STANDARDS

2.1 6TS RoHS 系列产品适用的相关标准是 UL248-1、UL248-14、CSA C22.2 NO.248.1-00、CSA C22.2 NO.248.14-00。

Applicable standards for 6TS RoHS series are UL248-1、UL248-14、CSA C22.2 NO.248.1-00、CSA C22.2 NO.248.14-00.

2.2 认证情况/ APPROVED DETAILS

额定电压 RATED VOLTAGE	认证范围 APPROVED RANGE	认证号码/ CERT. No.	
		UR/cUR	TUV
125V	1A-30A	E500879	T 50429696
250V			
300V			

3 公司地址/ ADDRESS

厦门火炬高新区(翔安)产业区翔安西路 8057 号第五层 A 区

Fifth floor A District, NO.8057 West Xiang'An Rd, Torch High-tech industrial District, Xiang'An, Xiamen

 XIAMEN DEXIAN ELECTRONICS TECHNOLOGY CO., LTD	PRODUCT SPECIFICATION	ISSUED DATE:	2019/08/20
		REV. NO.:	A00
	SERIES: 6TS	DOC. NO.:	DX-PSI-002
		PAGE	PAGE 2 OF 8

4 构造图/ CONSTRUCTION FIG. & DIMENSION

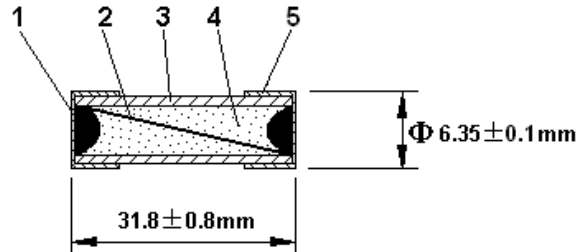

编号 No.	品名 PART	材料名 MATERIAL MODEL	备注 NOTE
1	焊锡/Solder	无铅焊锡/ Pb Free	/
2	可熔体/Element	金属丝/Metal Wire	/
3	管体/ Tube	陶瓷管/ Ceramic Tube	/
4	填充物/ Filler	石英砂/ Quartz Sand	/
5	铜帽/ Cap	黄铜/ Brass	镀镍/ Nickel Plated

4.1 陶瓷管/ CERAMIC TUBE

陶瓷管必须无缺陷破裂、缺损和污染。

The ceramic tube shall have no defects such as crack, injury and contamination.

4.2 铜帽/ CAP

铜帽应焊接牢固，以保证在未损坏熔断体时，铜帽不能被卸脱。样品在 15°C-35°C水中浸 24 小时取出后，在每个端帽上，均匀地施加拉力至 7N，保持 1 分钟，铜帽不应脱落。

Cap should be firmly attached so that it is not possible to remove them without damaging the fuse itself. The samples are immersed in water for 24 hours at a temperature between 15°C and 35°C. After remove from the water, an axial pull steadily increasing to 7N is applied to each cap for 1 minute.

4.3 焊点/ SOLDERING JOINT

焊接铜帽端时，铜帽外表面不能有残留的助焊剂、焊锡、可熔体等异物。

Soldering joint in end cap shall not be melted during normal operation and shall not have solder chips on tube, element in view and outer surface of caps.

4.4 准直度/ ALIGNMENT

取得 PSE 认证的保险丝管应能依自身重量能通过准直度卡规,准直度卡规的图形如下。

The entire length of the fuse shall pass through the gauge by the fuses own weight, which are approved by PSE. The construction of gauge is as follows.

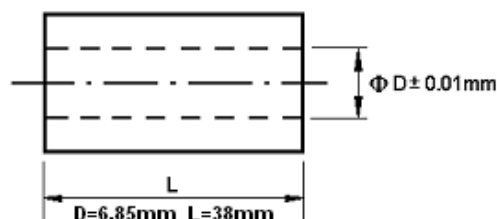

5 机械特性/ MECHANICAL PERFORMANCES

保险丝应能承受下列三项试验。/ Fuse shall be withstood following three testing.

5.1 扭力试验/ Rotational Strength

固定保险丝的一端铜帽，然后在另一端铜帽上顺时针和逆时针方向上顺序施加 50N·mm 力矩，两端铜帽不应松动，管体也不应破碎。

When one end cap of the specimen is fixed and then the torque 50N·mm is applied to the other end cap clockwise and counterclockwise, no looseness of end caps at both ends or damage of fuse-tube shall occur.

 XIAMEN DEXIAN ELECTRONICS TECHNOLOGY CO., LTD	PRODUCT SPECIFICATION	ISSUED DATE:	2019/08/20
		REV. NO.:	A00
	SERIES: 6TS	DOC. NO.:	DX-PSI-002
		PAGE	PAGE 3 OF 8

5.2 拉力试验/ Tensile Strength

固定保险丝的一端铜帽，然后在另一端铜帽上，沿水平轴方向施加 7N 的拉力，两端铜帽不应松动且管体不应破碎。

When one end cap of the specimen is fixed and then the tensile force 7N is applied to the other end cap in a direction to separate the end caps, no looseness of end caps or damage of fuse-tube shall occur.

5.3 管体强度试验/ Strength of Fuse-tube

两端铜帽固定好后，在玻璃管的中心位置施加 30N 的压力，管体不应破碎。

When middle parts of end caps at both ends of the specimen are supported and then the force 30N is applied to the middle part of the fuse-tube, no damage of the fuse-tube shall occur.

6 电气特性/ ELECTRICAL PERFORMANCE

6.1 测试条件/ TEST CONDITION

全部测试条件都应在环境温度 $24^{\circ}\text{C} \pm 3^{\circ}\text{C}$ 条件下进行，在此期间温度变化不允许达到 $+5^{\circ}\text{C}$ 和到极限范围

All electrical tests are conducted at an ambient temperature of $24 \pm 3^{\circ}\text{C}$. The ambient temperature is not allowed to vary more than 5°C during the test, and must be within these limits.

6.2 负载能力测试/ CURRENT-CARRYING CAPACITY TEST

当保险丝通以 100% 倍额定电流的条件下进行测试时，在 4 小时内电路不应断开，保险丝不被电流熔化，管体不破裂。

When a fuse is carrying 100% of rated current for continuing 4 hours and more, no open circuit, melt fusible element, or ruptured tube shall occur in any manner during this test.

6.3 温度上升试验/ TEMPERATURE RISE TEST

当保险丝通以 100% 倍额定电流的条件下进行测试时，在达到热量平衡后，测量保险丝表面的温度，保险丝表面的温度上升必须等于或低于 120°C 。注：温度上升=保险丝表面的温度-环境温度。

Measure the temperature of the surface of the fuse under the 100% rated current, when the thermal equilibrium reaches. The temperature rise on the surface of each fuse shall be 120°C or less.

Note: Temp. rise = fuse temp. - room temp..

6.4 预飞弧时间-电流特性/ PRE-ARCING TIME-CURRENT CHARACTERISTICS

当保险丝通以下表规定的电流时，其熔断时间必须符合下表的要求，且铜帽不能飞脱、管体不应破裂、损坏。

When the current in the following table is passing the fuse, its opening time must be in accordance with the requirements in the following table, that is, the pre-arcing time. Moreover, neither damage of the fuse-tube nor shattering of the cap shall occur.

熔断电流/ % of Rated Current	熔断时间/ Open Time
135%	1 hour Max.
200%	120 Sec. Max.

6.5 分断能力/ INTERRUPTING CAPACITY

这些型号的保险丝的分断能力应能达到下表规定的相应的各种安全认证的分断能力要求。保险丝分断电路后，保险丝管不应破裂、铜帽飞脱、且铜帽两端的绝缘电阻不小于 $0.1\text{M}\Omega$ 。

The interrupting capacity should reach the interrupting rated current given in the following table. And after this test, there should be no damage of the fuse-tube or shattering of the caps. After this test, the insulation resistance between the end caps shall be not less than $0.1\text{M}\Omega$.

额定电压 RATED VOLTAGE	分断电流/ INTERRUPTING CURRENT	
	UR/ cUR	TUV
125V/250V/300V	1,000A	1,000A



XIAMEN DEXIAN ELECTRONICS
TECHNOLOGY CO., LTD

PRODUCT SPECIFICATION

SERIES: 6TS

ISSUED DATE:

2019/08/20

REV. NO.:

A00

DOC. NO.:

DX-PSI-002

PAGE

PAGE 4 OF 8

6.6 平均 I-T 特性曲线图(仅供参考)/ THE AVERAGE I-T CHARACTERISTICS CURVE(FOR REFERENCE ONLY)

6TS Average I-T Characteristics Curve(For Reference Only)
6TS 平均电流-时间曲线图(仅供参考)

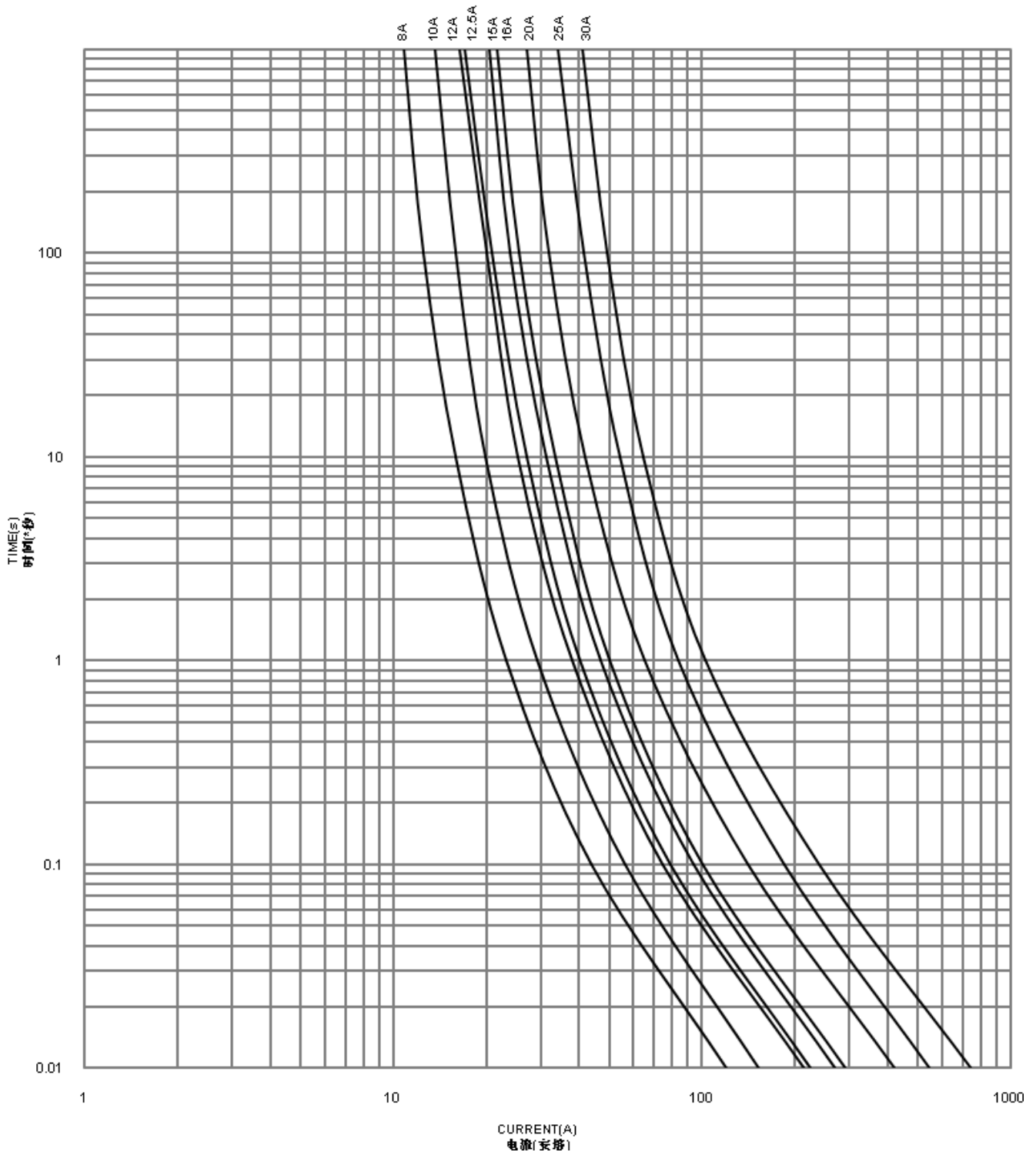

 XIAMEN DEXIAN ELECTRONICS TECHNOLOGY CO., LTD	PRODUCT SPECIFICATION	ISSUED DATE:	2019/08/20
		REV. NO.:	A00
	SERIES: 6TS	DOC. NO.:	DX-PSI-002
		PAGE	PAGE 5 OF 8

6.7 平均 I²T-T 特性曲线图(仅供参考) / THE AVERAGE I²T-T CHARACTERISTICS CURVE(FOR REFERENCE ONLY)

6TS Average I²T-T Characteristics Curve(For Reference Only)

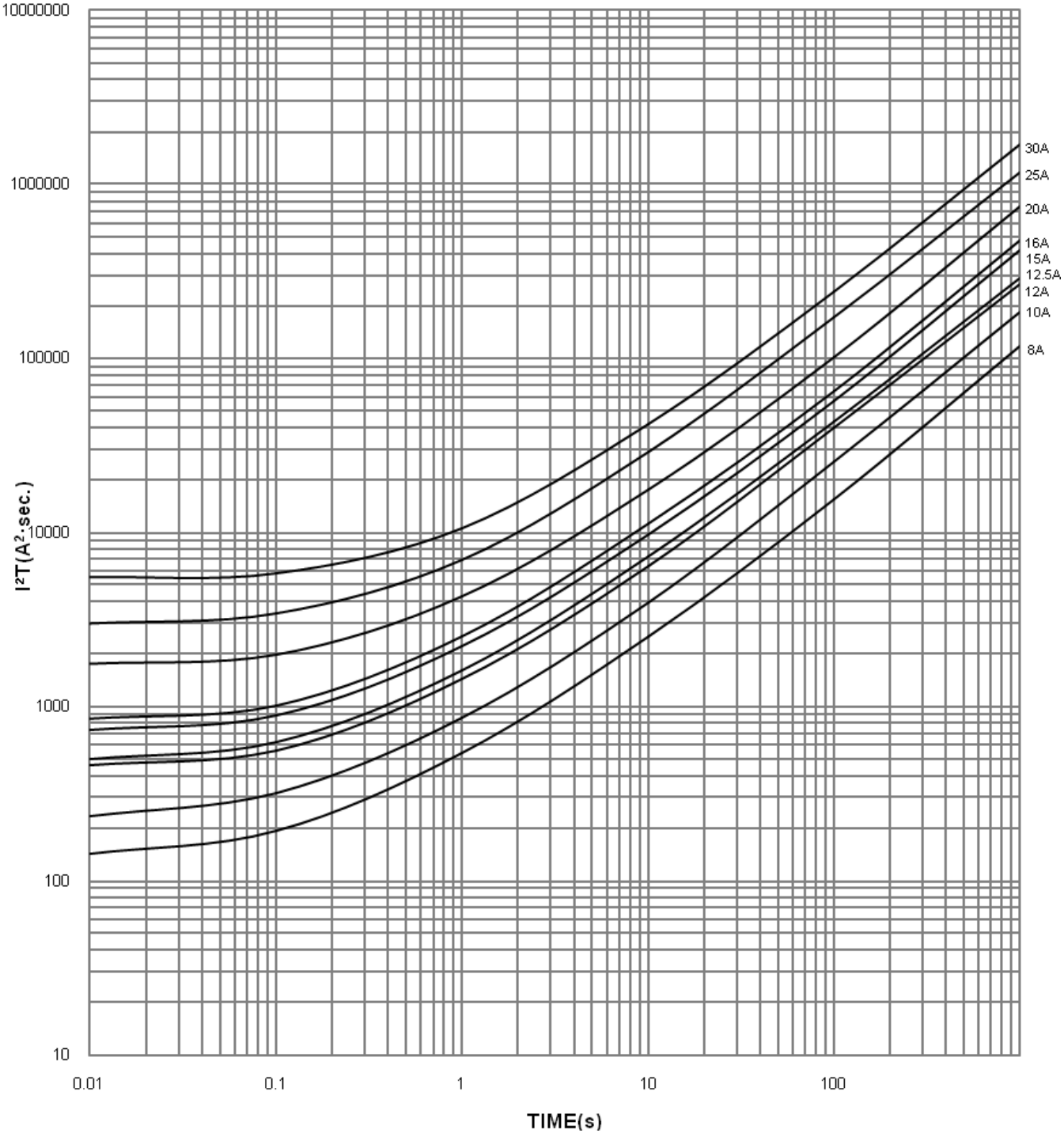

 XIAMEN DEXIAN ELECTRONICS TECHNOLOGY CO., LTD	PRODUCT SPECIFICATION	ISSUED DATE:	2019/08/20
		REV. NO.:	A00
	SERIES: 6TS	DOC. NO.:	DX-PSI-002
		PAGE	PAGE 6 OF 8

6.8 电阻测试/ COLD RESISTANCE TEST

环境温度为 $25 \pm 2^\circ\text{C}$ ，测试电流不大于保险丝额定电流的 10%。

Input 10% of fuse rated current to fuse for cold resistance test at surrounding temperature of $25 \pm 2^\circ\text{C}$.

7 产品标志/ MARKING

7.1 保险丝上的标志应易于看清。

The relevant markings shall be marked on the caps of the fuse and shall be easily visible.

7.2 每个保险丝应标有下列标记。

The markings for every fuse shall be prescribed as below according to the types.

1) 安全认证标志/ Safety approval logo: 

2) 型号名称/ Type: 6TS

3) 商标/ Trademark: 

4) 额定电压/ Rated Voltage

5) 额定电流/ Rated Current

注: 1)、2) 和 3) 应标注在保险丝管一端铜帽的侧面。

Note: 1), 2) and 3) should be marked on the one side cap of the fuse.

4) 和 5) 应标注在保险丝管另一端铜帽的侧面。

4) and 5) should be marked on the other side cap of the fuse.

8 包装要求/ PACKAGING DETAILS

8.1 外箱包装方式/ EXPORTED CARTON PACKING

8.1.1 参考尺寸: 长×宽×高=355×295×260mm。

Reference Dimension: length×width×height=355×295×260mm.

8.1.2 包装细节: 100 个/小塑料袋; 5 小塑料袋/盒; 10 盒/每箱。

Packaging Details: 100EA/ little plastic-bag; 5 little plastic-bags/ box; 10 boxes/ Exported Carton.

产品的包装应能达到防潮、抗振的作用, 以防在运输或贮存过程中产品受潮或损坏。

Packing shall be so carried out that the products will not absorb moisture or be damaged during transportation or storage.

8.2 标签/ LABEL

标签应包括型号、额定电流、额定电压、分断电流、商标、安全标志、批量号码、公司名称、RoHS 标志、绿色“G”和“QA”标志。

The label in the smallest package in which the fuses are put shall contain the Type, Rated current, Rated voltage, Interrupting current, Trademark, Safety approval logo, Lot. No., Company name, “RoHS” mark, green “G” and “QA” mark.

例批量号:

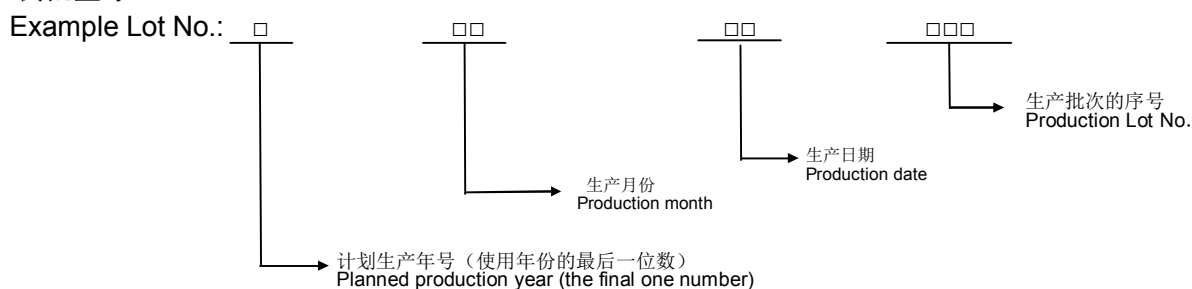

9 环境参数/ ENVIRONMENT PARAMETERS

9.1 工作温度/ Operating Temperature: $-55^\circ\text{C} \sim 125^\circ\text{C}$.

9.2 储存温度/ Storage Temperature: $-55^\circ\text{C} \sim 85^\circ\text{C}$.

 XIAMEN DEXIAN ELECTRONICS TECHNOLOGY CO., LTD	PRODUCT SPECIFICATION	ISSUED DATE:	2019/08/20
		REV. NO.:	A00
	SERIES: 6TS	DOC. NO.:	DX-PSI-002
		PAGE	PAGE 7 OF 8

10 信赖性试验/ RELIABILITY TEST

项目/ Item	试验要求/ Test Requirement	试验条件/ Test Condition
高温试验 High Temperature Test	试验后保险丝管的电阻符合范围; 电气特性符合: $200\% \leq 2$ 分钟、 $135\% \leq 1$ 小时、 $100\% \geq 4$ 小时。 After high temperature test, the resistance value of the fuses shall be in range. Electrical Characteristics: $200\% \leq 2$ minutes, $135\% \leq 1$ hour, $100\% \geq 4$ hours.	测试温度: $105 \pm 2^\circ\text{C}$, 测试时间: 1000 小时。 Test Temperature: $105 \pm 2^\circ\text{C}$, Test Time: 1000hours.
低温试验 Low Temperature Test	试验后保险丝管的电阻符合范围; 电气特性符合: $200\% \leq 2$ 分钟、 $135\% \leq 1$ 小时、 $100\% \geq 4$ 小时。 After low temperature test, the resistance value of the fuses shall be in range. Electrical Characteristics: $200\% \leq 2$ minutes, $135\% \leq 1$ hour, $100\% \geq 4$ hours.	测试温度: $-20 \pm 2^\circ\text{C}$, 测试时间: 1000 小时。 Test Temperature: $-20 \pm 2^\circ\text{C}$, Test Time: 1000hours.
高湿试验 High Humidity Test	试验后保险丝管的电阻符合范围; 电气特性符合: $200\% \leq 2$ 分钟、 $135\% \leq 1$ 小时、 $100\% \geq 4$ 小时。 After high humidity test, the resistance value of the fuses shall be in range. Electrical Characteristics: $200\% \leq 2$ minutes, $135\% \leq 1$ hour, $100\% \geq 4$ hours.	测试温度: $40 \pm 2^\circ\text{C}$, 测试湿度: 90%~95%, 测试时间: 96 小时。 Test Temperature: $40 \pm 2^\circ\text{C}$, Test Humidity: 90%~95%, Test Time: 96hours.
热冲击试验 Thermal Shock Test	试验后保险丝管的电阻符合范围; 电气特性符合: $200\% \leq 2$ 分钟、 $135\% \leq 1$ 小时、 $100\% \geq 4$ 小时。 After thermal shock test, the resistance value of the fuses shall be in range. Electrical Characteristics: $200\% \leq 2$ minutes, $135\% \leq 1$ hour, $100\% \geq 4$ hours.	每个循环: -40°C 放置 30 分钟后 85°C 放置 30 分钟, 测试 10 循环。 $-40^\circ\text{C} / 30\text{mins} \rightarrow 85^\circ\text{C} / 30\text{mins}$, 10 cycles.
落下、冲击试验 Falling Shock Test	铜帽应固定牢固, 以保证在未损坏熔断体时, 铜帽不能被卸下。铜帽表面镀层应牢固不易脱落, 每个端帽应能经受专用的设备外加的轴向拉力 7N, 保持 1 分钟。陶瓷管必须无缺陷破裂、缺损和污染。试验后保险丝管的电阻符合范围; 电气特性符合: $200\% \leq 2$ 分钟、 $135\% \leq 1$ 小时、 $100\% \geq 4$ 小时。 Cap should be firmly attached so that it is not possible to remove them without damaging the fuse itself. The means of attachment shall be sufficient to withstand an axial pull of 7N applied to each cap for 1 minute. The cap shall be nickel plated firmly. The ceramic tube shall have no defects such as crack and injury. After falling shock test, the resistance value of the fuses shall be in range. Electrical Characteristics: $200\% \leq 2$ minutes, $135\% \leq 1$ hour, $100\% \geq 4$ hours.	一箱 5,000 个保险丝管从一米高自由落下, 跌落 20 次。 5,000EA fuses/ one external carton, Falling Height: 1 meter, Falling Times: 20.

 XIAMEN DEXIAN ELECTRONICS TECHNOLOGY CO., LTD	PRODUCT SPECIFICATION	ISSUED DATE:	2019/08/20
		REV. NO.:	A00
	SERIES: 6TS	DOC. NO.:	DX-PSI-002
		PAGE	PAGE 8 OF 8

Package

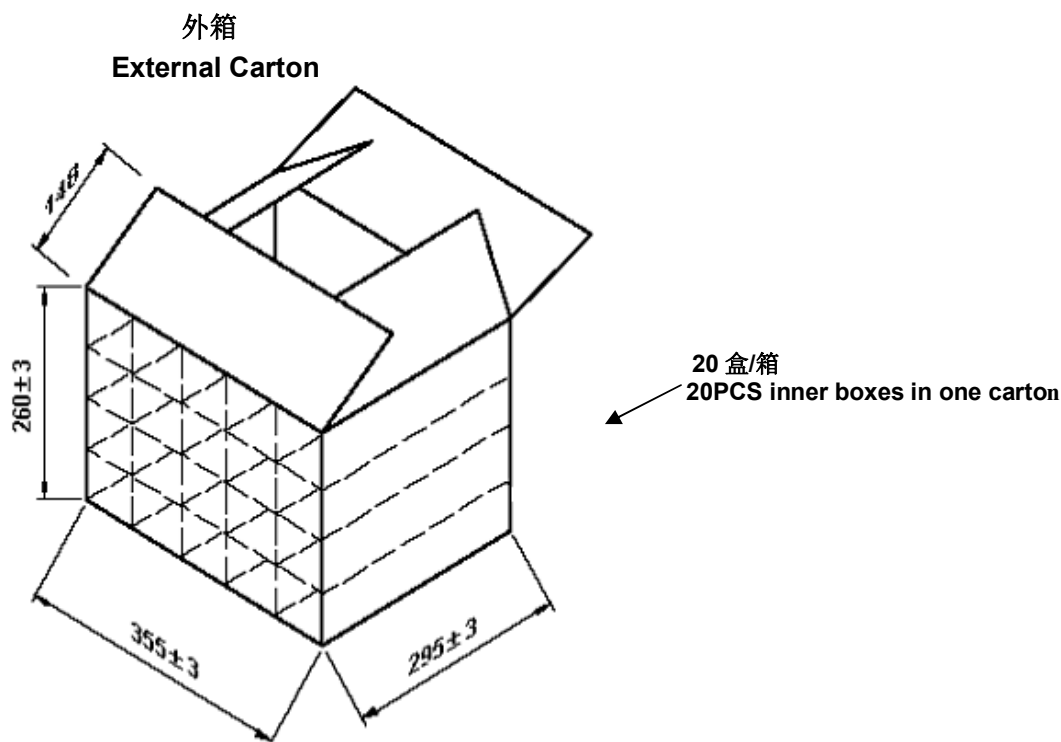
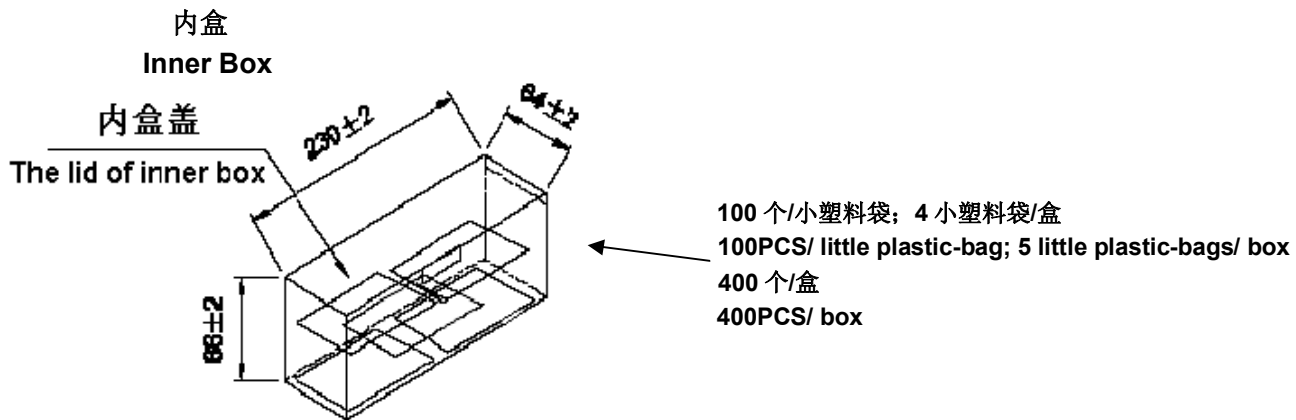

1 重量 Weight

一个外箱(装满 8,000 个保险丝管)毛重 23.3 公斤/净重 21.6 公斤。

One external carton(filled with 8,000PCS fuses): G.W. 23.3Kgs/ N.W. 21.6Kgs.

2 原材料 Material

内盒 Inner box: 纸板 Cardboard.

外箱 External carton: 双层瓦楞纸 Double layer corrugated paper, 厚度 Thickness>6mm.

3 印刷标志 Printing and Marking

外箱需有公司名称、电话、传真、电子邮箱、网址、商标、安全标志、RoHS 等标志。

External carton With Company name, Tel, Fax, E-mail, Web site, Trade make, Safety approval logo, RoHS registered firm etc..

单击下面可查看定价，库存，交付和生命周期等信息

[>>DXFUSE\(厦门得线\)](#)